

mellerware®

E X E C U T I V E
I C E M A S T E R I C E M A K E R



complies with
INTERNATIONAL
IEC60335
SAFETY SPECIFICATIONS

m
100W

2 YEAR
GUARANTEE

Model:
ICM001A

PLEASE READ ALL INSTRUCTIONS BEFORE USE

2 year guarantee



Dear Customer,

Many thanks for choosing to purchase a Mellerware brand product. Thanks to its technology, design and operation and the fact that it exceeds the strictest quality standards, a fully satisfactory use and long product life can be assured. It is important that you read these instructions before using your portable ice maker and keep them in a safe place for future reference.

GETTING TO KNOW YOUR UNIT

GENERAL:

- 1 - Ice lifter.
- 2 - Ice full sensor.
- 3 - Ice basket.
- 4 - Top cover with transparent window.
- 5 - Air outlet.
- 6 - Water drain cap: at the front of the base of the unit.
- 7 - MAXIMUM WATER LEVEL: 

Remove the ice basket and you are able to see the water level mark.

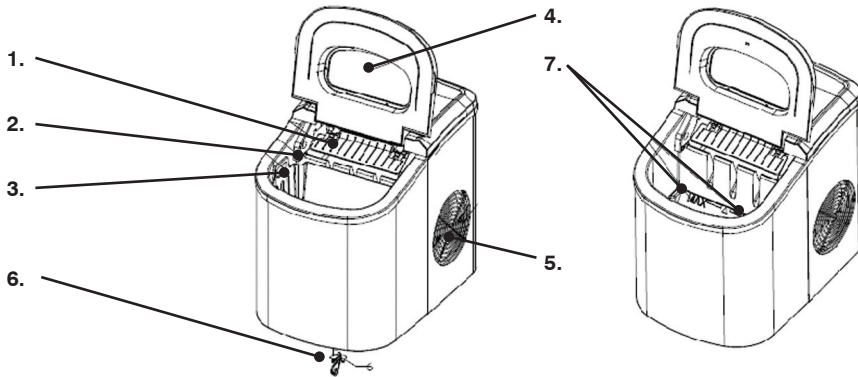

POSITION OF CONTROL PANEL & FUNCTION

CONTROL PANEL:

- A - Selected ice size displaying: QUICK and NORMAL.
- B - Power indicator
- C - Ice full indicator
- D - Water shortage indicator
- E - Button to turn on/off the unit.
- F - Button to select ice cube size.

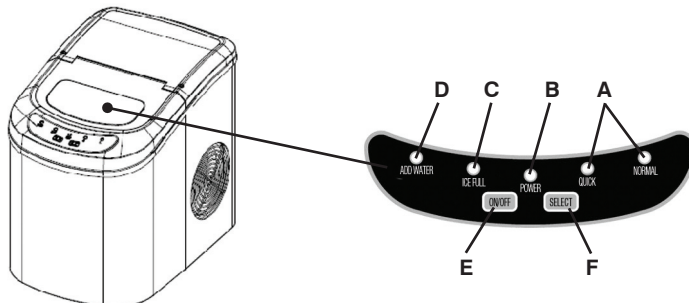



PREPARING YOUR ICE MAKER FOR USE

When using electrical appliances, basic safety precautions should be followed to reduce the risk of fire, electric shock, and injury to persons or property. Read all instructions before using any appliance.

SAFETY ADVICE:

- Do not operate this appliance with a damaged power cord. If the power cord is damaged, it must be replaced by the manufacturer or its service agent or a similarly qualified person in order to avoid a hazard.
- Ensure that the voltage on the rating label corresponds with the voltage of the wall socket. No other appliance should be plugged into the same wall socket when using this appliance. Ensure that the plug is fully inserted into the wall.
- Do not allow the power cord to come into contact with hot, rough or sharp surfaces and objects.
- Do not allow the power cord to hang over the edge of the counter.
- Do not use this appliance with plug adaptors and extension cords.
- Switch off the appliance & remove the plug from the wall socket before undertaking any cleaning task or when the appliance is not in use.
- This appliance is intended for household use only. Do not use the appliance outdoors.
- Do not place this product in direct sunlight.
- Ensure that there is a 10cm gap between the unit and surrounding objects.
- Do not use any other liquids to make ice-cubes other than clean water.
- Do not clean your ice maker with flammable or hazardous fluids. The fumes can create a fire hazard or an explosion and could be hazardous to your health.
- Do not tilt or turn the appliance over. This appliance should remain upright at all times.
- This appliance is not intended for use by persons (including children) with reduced physical, sensory or mental capabilities, or lack of experience and knowledge, unless they have been given supervision or instruction concerning use of the appliance and are supervised during use of the appliance by a person responsible for their safety.

- Children should be supervised to ensure that they do not play with the appliance.
- Use the appliance in a well ventilated area.
- Do not place the appliance on hot surfaces, such as cooking plates, gas burners, ovens or similar.

CAUTION: In order to prevent overheating do not cover the appliance.

- Do not use the appliance if it has fallen on the floor, if there are visible signs of damage or if it has a leak.
- Do not pull on the power cord to remove the plug from the wall socket. Do not use the power cord to lift, pull or carry the appliance.
- Always use the appliance on an even surface.
- Do not touch the plug, power cord or appliance with wet hands.
- Do not submerge the plug, power cord or appliance in water or any other liquid.
- Only use this appliance for its intended purpose.
- Only use the accessories provided with this appliance. Using other accessories can cause the appliance to malfunction.
- Do not touch the evaporator while the appliance is in use.

OPERATING PROCEDURES & MAINTENANCE

UNPACKING YOUR ICE MAKER:

1. Remove the exterior and interior packaging. Check if ice basket and ice scoop are inside. If any parts are missing, please contact our customer service department.
2. Remove the tape securing the ice shovel, ice basket & ice scoop in place. Clean the tank & ice basket.
3. Put the ice maker on a level counter top away from direct sunlight or any other sources of heat.
4. Ensure that the unit has a 10cm space on all sides from surrounding objects.
5. Allow the water to circulate through the product until it indicates "ADD WATER".
6. Empty all water and refill the product with fresh clean water.
7. Only use cold water when using this product.
8. To get larger, more dense ice bullets, use





refrigerated cold water.

WARNING: fill with fresh clean water only.

CONNECTING YOUR ICE MAKER:

***If the plug, power cord or appliance is damaged in any way, please return the unit to the manufacturer or their designated service agents to avoid the risk of electric shock or injury.**

1. This unit should only be used in a single standard wall socket. Ensure that the plug fits securely and correctly into the wall socket. Do not try to alter or change the plug as this could be dangerous and will render the warranty null & void.
2. This appliance requires a wall socket that is capable of a supply of 220-240V, 50Hz.

CLEANING & MAINTAINING YOUR ICE MAKER:

Before using your ice maker, clean the appliance thoroughly as explained in “OPERATING PROCEDURES & MAINTENANCE”.

1. Take out the ice basket.
2. Clean the removable ice basket & ice shovel with diluted detergent, warm water and a soft cloth. Then rinse with clean warm water.
3. Use clean water to rinse the inside parts, and drain out the water by removing the water drain cap on the right front bottom corner of the base. Ensure to pour the water out into a sink/basin and dispose of the water correctly.
4. The outside of the ice maker should be cleaned regularly with a mild detergent solution and warm damp cloth. Rinse with a clean damp cloth.
5. Clean the water tank with water and a mild detergent using a soft damp cloth, then rinse with a clean soft damp cloth.
6. Dry the interior and exterior with a clean soft cloth.
7. When the product is no longer required for regular use, drain all water & dry the interior.

USING YOUR ICE MAKER:

1. Clean the unit following the instructions under the “Cleaning and maintaining your ice maker” section of this instruction manual. Open the

cover, remove the ice basket and pour water into the tank. Keep water level below the “MAX” water level mark.

2. Press the “ON/OFF” button on the control panel to begin the ice making cycle.
 3. Select the ice cube size by pressing the “SELECT” button. If the room temperature is lower than 15°C, it is recommended that the small ice cube setting is selected in order to avoid ice bullets sticking together.
 4. The ice making cycles last approximately 6 to 13 minutes, depending on selection of ice cube size and the room temperature. The room temperature should be between 10°C to 35°C when making ice.
 5. If the water pump can't supply water to the ice making box, the ice maker will stop automatically, and the “Add Water” indicator will illuminate. Press the “ON/OFF” button to switch the unit off then fill water up to the maximum water level mark and press “ON/OFF” button again to switch the unit on.
 6. The unit stops when the ice basket is full and the “Ice Full” indicator is illuminated. Remove the ice bullets and replace the empty ice basket to continue making ice.
- WARNING:** Direct sunlight or sunlight reflection may cause the infrared sensor to malfunction. If the unit doesn't stop when the ice cubes obstruct sensor, please contact the customer care department and seek advice.
7. Change the water in the water reservoir every 24 hours to ensure a safe hygiene level.





TROUBLESHOOTING

PROBLEM	POSSIBLE CAUSE	SOLUTION
“Add Water” indicator is on.	Little water in water reservoir.	Switch off the ice maker, fill water, and press “ON/OFF” button again to restart the unit.
“Ice Full” indicator is on.	The ice basket is full.	Remove ice from ice basket. Replace the empty ice basket immediately to prevent the next batch ice bullets from falling into the water reservoir.
Ice cubes stick together.	The ice making cycle is too long.	Stop the ice maker, and restart it when the ice blocks melt. Select the small size ice cube selection.
	Water temperature in inner tank is too low.	Replace the water. Temperature of water recommended at 8-22°C.
Ice making cycle is normal but no ice formed.	Room or water temperature in inner tank is too high.	The room temperature should be 10-35°C, water temperature should be 8-22°C.
	Refrigerant in cooling system may be leaking.	Return product to service center to be verified by a qualified technician.
	Pipe in the cooling system could be blocked.	Return product to service center to be verified by a qualified technician.

WARRANTY INFORMATION

WARNING: Keep the ventilation opening of the appliance clear of obstructions and a minimum space of 10cm from surrounding walls and surfaces.

WARNING: Do not damage the refrigerant circuit.

- The warranty only covers defects in material or regular and proper use of the appliance.
- The repairs under warranty may only be carried out by an authorized service centre. When making a claim under the warranty, the original proof of purchase (with purchase date) must be submitted.

The warranty will not apply in cases of:

- Normal wear and tear.
- Incorrect use, e.g. overloading the appliance, use of different accessories.
- Use of force, damage caused by abuse and neglect.
- Damage caused by not following instructions as set out in this instruction manual.
- Partially or completely dismantled appliances.

The warranty will be rendered null & void if the appliance shows any signs of abuse, neglect, incorrect use of the appliance or any attempt to dismantle or repair the appliance.







creative housewares

 20 Tekstiel Street, Parow, Cape Town, 7493, South Africa

 P.O. Box 6156 Parow East, 7501, South Africa

 +27 21 931 8117  +27 21 931 4058

Service Centre Helpline: 086 111 5006

 www.creativehousewares.co.za

